

# LP-II

VER 2.00

## Thermal Label Printing Scale

### FEATURE PACKED !

- FAST & SIMPLE OPERATION
- 60 lb CAPACITY & DUAL-RANGE !
- 30 kg AT THE TOUCH OF A BUTTON !
- MENU-DRIVEN & USER-FRIENDLY
- HIGH SPEED THERMAL PRINTER
- FREE FORMAT LABEL DESIGN
- RUGGED TACTILE KEYS
- NETWORK BY USING ETHERNET
- OVER 1,500 CHARACTERS PER PLU !
- CASH DRAWER
- 99 FLOATING CLERK!
- **ADVANCED WINDOWS® 95/98/2000/XP FULLY FEATURED SCALE SOFTWARE !**



**ISO 9001 Certified** WE WEIGH THE WORLD !



# CAS

# Label Printing Scale

# LP-II

## FLEXIBLE AND RELIABLE NETWORKING

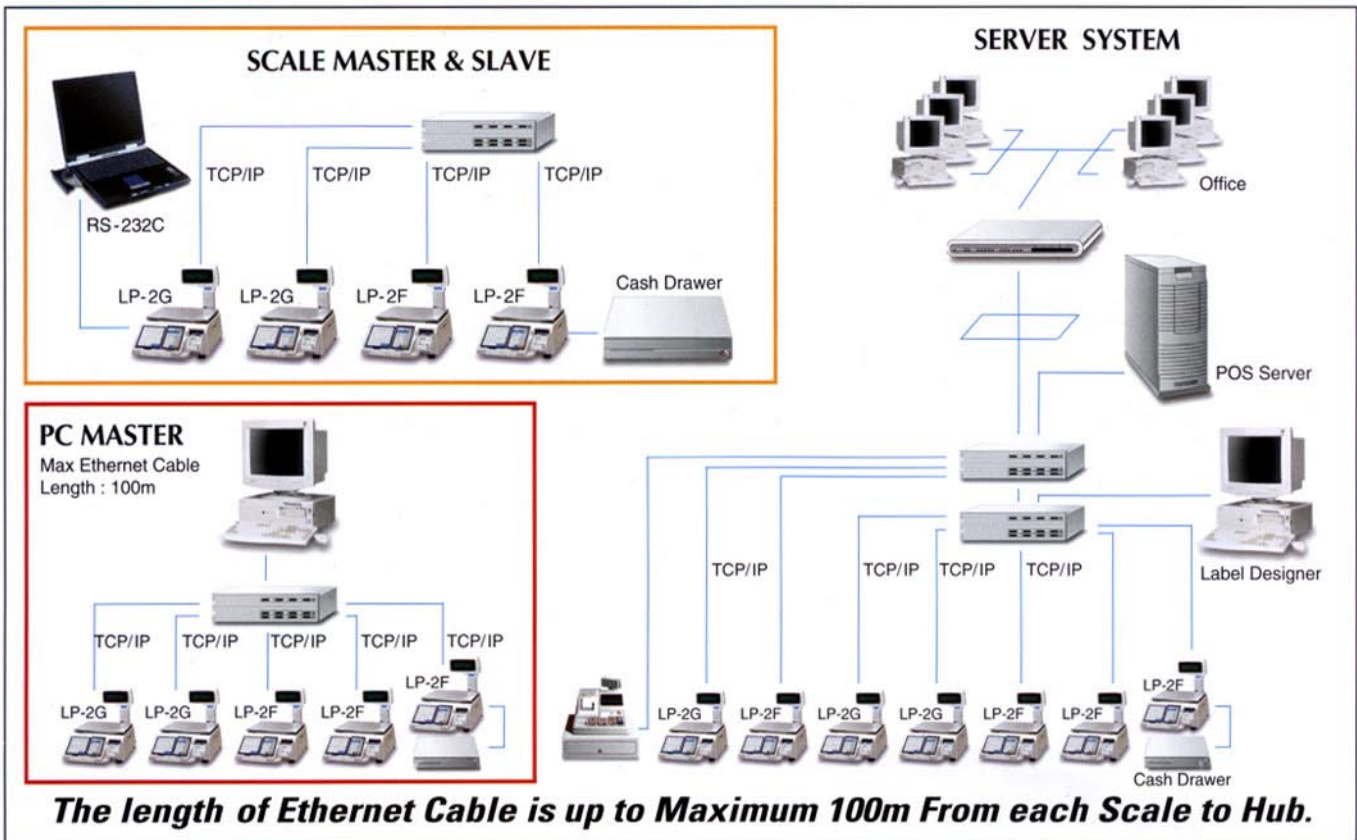

## FEATURES

### SCALE NETWORK

: LP-II uses Ethernet(TCP/IP) for the network to program, update, and maintain sales data for up to 99 scales when PC is master. When scale is master, then up to 10 scales can be connected. With 6 digit PLU numbers that can be assigned to 32 departments, you can partition the sales data to suit any need. The master receive sales data from all scales the moment sales are transacted.

### TACTILE SWITCH KEYBOARD

- 106 Speed keys, [53 × 2 (SHIFT)]
- Sealed keyboard minimizes possible damage from moisture.
- LP-II use heavy-duty tactile switches instead of membrane "keypads".
- Keys strategically placed in order to minimize user effort.

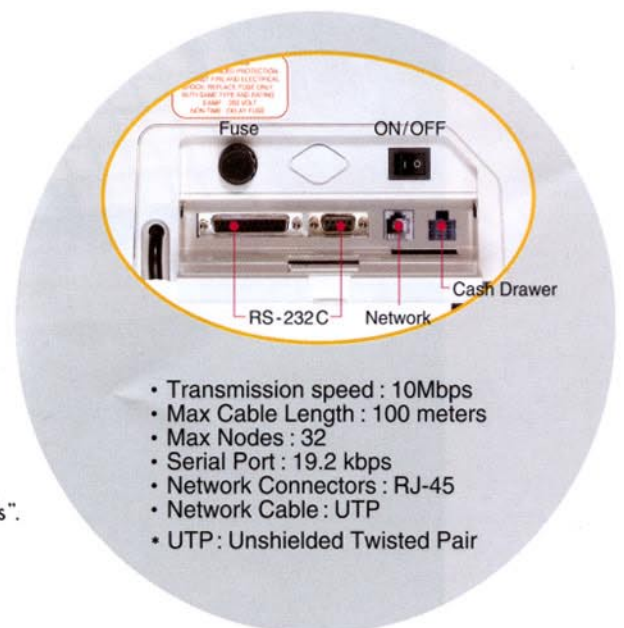

- Transmission speed : 10Mbps
- Max Cable Length : 100 meters
- Max Nodes : 32
- Serial Port : 19.2 kbps
- Network Connectors : RJ-45
- Network Cable : UTP
- UTP: Unshielded Twisted Pair



# LP-II Software Package

## ADVANCED PC SOFTWARE

With so many advanced features, how can you keep track of it all ? You would probably need a PC, sophisticated and expensive software, and highly trained personnel to work with it. Here at CAS we think simpler is better, so we narrowed it down to one requirement : a PC running Microsoft® Windows® 95/98/2000/XP OS. Every LP-II\* comes with a trial version of the LP-II software package that gives you the power to program, edit, and update virtually every feature of the LP-II. The LP-II also gives you the power of designing your own label formats on the PC in WYSIWYG (What You See Is What You Get). You can design up to 1000 label formats per store-file ! You can manage virtually an unlimited number of stores ! So long as you have hard-drive space you can manage as many stores of up to 32 LP-II scales per store. With such powerful software and advanced scales, you can't go wrong with the LP-II !

## THOUSANDS OF PLUs AT YOUR FINGER TIPS

Whether you have a specialty store or an average deli, you can keep track of all your PLU's prices, sales, availability, advertising, etc. Sort your PLUs in various ways and generate a computer printout for fast accurate data base management. Do you need to generate labels for some items that are not scalable or food related ? No problem ! The LP-II has 3 types of PLUs: Weighed, Non-Weighed, and Non-Food. Each has its own unique uses but all are flexible enough to fit virtually any demand.

## 32 INDEPENDENT DEPARTMENTS

Whether installed on a network or standalone, each scale can be assigned to one of 32 programmable departments. This allows that scale to directly select all PLUs from that department for quick and accurate access. But what if you are in a jam and you need scale #1 to access PLUs from another department ? You can do that too ! You can also indirectly access all other PLUs from ALL other departments. This numbering scheme allows for 32,999,999 PLU numbers ! Wow ! This also will let you use the same PLU number across different departments: PLU # 1 in Deli Department may be different from PLU # 1 in Bakery.

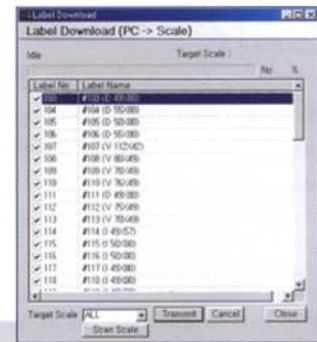

Label Download Screen

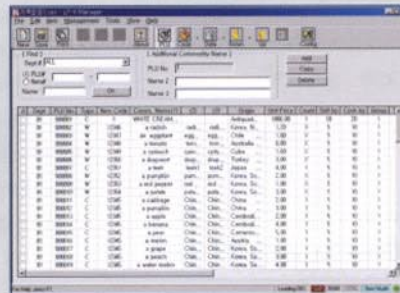

PLU Create/Edit Screen

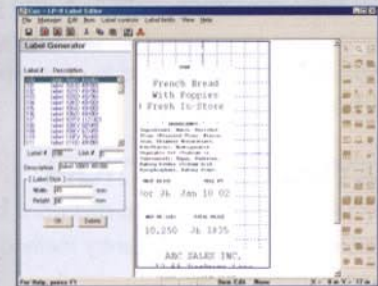

Label Formatting Screen

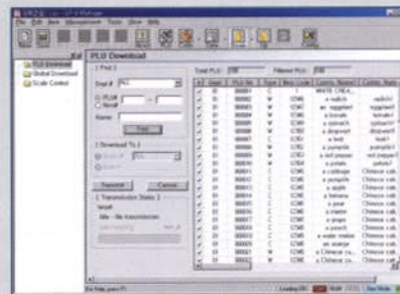

PLU Download Screen



Preview Report

## PROGRAMMABLE DATA

### PLU:

- Department # : 1-32
- PLU # : 1-999999
- Commodity Name : 114 Char
- Label Format # : 1-999
- Sales Message # : 1-99
- Unit : lb, kg
- Group Code : 0-999
- Tax Rates : 0-3
- Region Code : 0-99
- Sell By Date : 0-999 days
- Cook By Date : 0-999 days
- Tare Weight : 0-Capacity
- Price/Total price : 0.00-999.99
- Sale Weight : 0-Capacity
- Sale Price : 0.00-999.99
- Net Weight : 0-9999
- Count : 1-999
- Sale Count : 0-999
- UPC : 0-999999
- Ingredients : 2000 Char
- Origin : 25 Char
- Barcode Type/Format
- Nutritional Information

### General:

- Scrolling Messages : 99@80 Char
- Sales Messages : 99@40 Char
- Store Name : 150 Char
- Departments : 32@40 Char
- Users/Clerks : 99@20 Char
- Label Formats : 900@30 Char
- Label Formats : 50 Built-in
- Origin : 400@25 Char



# HIGH SPEED NETWORK FOR ADVANCED SOLUTIONS

**Advanced features & user-friendly menu driven programming.**

## EASY-TO-FOLLOW INSTRUCTIONS

- Large bright Vacuum Fluorescent Display.
- Graphical display guides user on how to proceed with sales or programming.
- Dot-Matrix VFD : 256 x 64 resolution.
- 7-segment VFD

## VARIABLE LABEL SIZES

- Max Width : 80 mm (3.15 in.)
- Max Length : 170 mm (6.70 in.)
- Max Roll Diameter : 12 cm (4.72 in.)

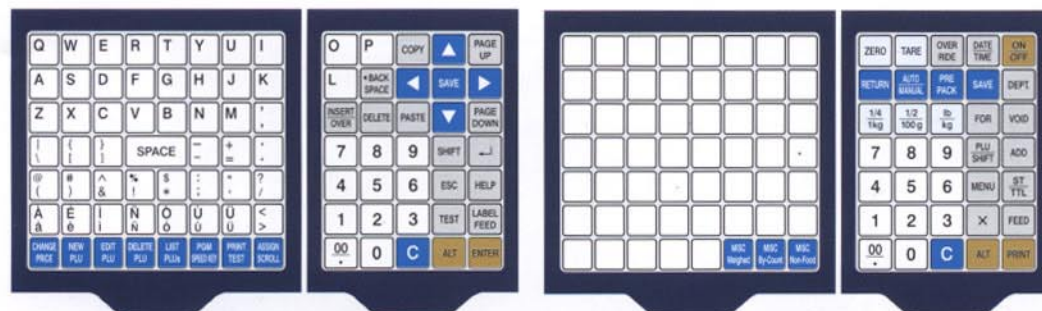

SIDE A: PROGRAM MODE

SIDE B: REGISTRATION MODE

## ADVANCED FEATURES

- Convenient Cash Drawer.
- Pc trial software included-PLU/ Global data download, upload etc.
- Fast speed 1Mbps network.
- Extended memory
- Display:Graphic VFD/ 7-segment display



# SPECIAL TODAY...



## SCROLLING MESSAGES

- Each scale can sequence & display up to 4 different messages from a list of 99 user programmable messages !
- Each message can be shown using any of 6 special effects !

## IDEAL FOR HIGH VOLUME

The LP-II uses very high-quality thermal print head and printer parts designed to run in the toughest environments. Large printer compartment can house high capacity label rolls eliminating the need for frequently replacing the finished label roll.

## SECURITY

With "password protection" the LP-II is able to keep unauthorized users from operating the scale. You can also use the security features to grant limited access to certain users. Assigning various levels of access to different users allows the scale to be securely operated in practically any environment.

## PREPACKAGING

The LP-II has several features to aid in any backroom application. The PRE-PACK mode enables the user to quickly print labels without the hassle of having to press the PRINT key with every transaction. PREPACK also prevents the AUTOCLEAR feature from interrupting the packaging process. The AUTO and SAVE features can be used to accommodate "special" packaging needs.

## KEYLESS OPERATION

With the LP-II there are no awkward keys to loose or locks to fumble with. A password entry method allows for up to 99 users per network or scale.

## BAR - CODING

The LP-II has 9 built-in barcode types to choose from. Selecting the "open bar-code" option in PGM mode allows the LP-II to print virtually any barcode format. Additionally, each PLU can have its own unique barcode type and format. For maximum convenience the LP-II can print multiple barcodes on each label.

## BATTERIES AND MEMORY

You just got your new LP-II on Friday morning and finally finished programming 400 PLUs into your new LP-II by Friday night. You return on Monday only to find out that you left your scale unplugged ! All that work down the drain ! This would be true if the LP-II used battery backed RAM like all other printing scales... but it doesn't. The LP-II uses Flash RAM which needs no power to maintain its contents ! So, if you leave it unplug for 1 weekend or 1000 weekends it doesn't matter ! You will never loose your programming due to low or dead batteries !

## SALES REPORTING

If keeping track of sales through the POS system or cash register just isn't enough, then the LP-II can also aid in tracking sales. You can print or display numerous types of sales data: X MODE for reading sales data and Z MODE for reading and resetting. On a network, the Master and Mirror Master scales are updated on-the-fly in order to keep accurate account of storewide sales at all times ! Out of continuous strip media? Need to print sales reports ?... Any label will do ! So long as the LP-II has labels or media of any type, you can print perfectly legible sales reports.

## SPECIFICATIONS

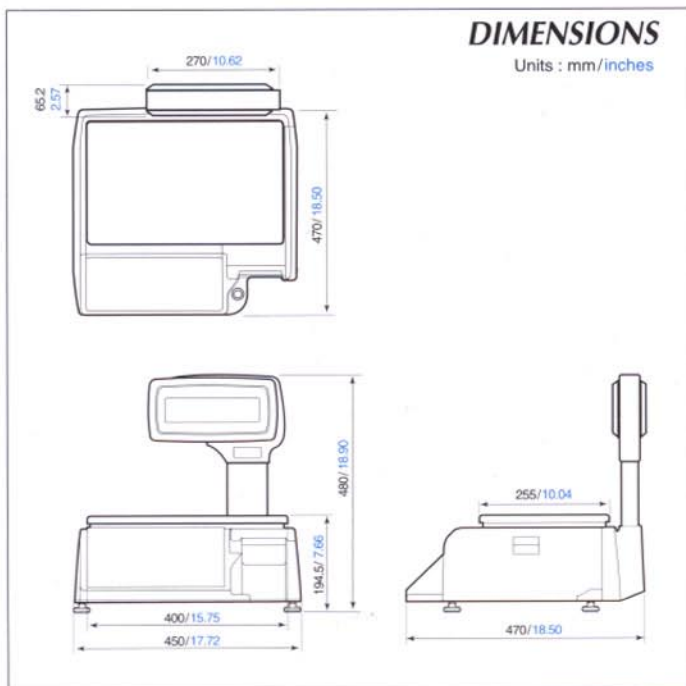

MODEL	LP - II
CHARACTERS PER PLU	Ingredients : 2000 char. MAX PLU Name : 114 char. MAX
DISPLAYS	WEIGHT : 5 digits (5 max) UNIT PRICE : 6 digits (8 max) TOTAL PRICE : 7 digits (9 max)
INTERFACES	RS-232 Serial Ports : COM 1/Ethernet Port
MAX TARE	FULL CAPACITY
MEASUREMENT TYPE	LOAD CELL
MEMORY CAPACITY	Over 800 PLUs (Standard memory configuration.)
MEMORY OPTION	Over 4000 PLUs (Expanded with optional memory card.)
NETWORK	• 32 Scale MAX • Optional Network card required
SPECIFICATIONS	• 99 Clerks MAX • 100m (0.06 miles) max cable length
OPERATING TEMP.	- 10°C ~ + 40°C (14° F ~ 104° F)
PLATTER SIZE	(L)403mm (15.87 in.) (W)260mm (10.24 in.)
POWER SOURCE	85~240VAC 50/60Hz ± 5%
PRINT SPEED	100mm/sec (4 in./sec)
PRINTER TYPE	DIRECT THERMAL PRINT
SALES PERIODS	Dual totals for daily/monthly or user selectable reporting periods.
SALES REPORT MODES	Read : × 1/× 2 Modes Read & Reset : Z1/Z2 Modes
SHIPPING WEIGHT	13kg (29 lb)
WEIGHING CAPACITY	0~15 × 0.005 lb / 15~30 × 0.01 lb 0~30 × 0.01 lb / 30~60 × 0.02 lb (0~3 × 0.001 kg / 3~6 × 0.002 kg, 0~6 × 0.002 kg / 0~15 × 0.005 kg, 0~15 × 0.005 kg / 15~30 × 0.01 kg)
WEIGHING RANGE	DUAL RANGE
WEIGHING UNITS	Pound & Kilo push-button selectable.

Note : Specifications are subject to change without notice.



## IF THE SHOE FITS...

Free-formatting, a large capacity label compartment, and an extra wide print head allow the LP-II to print on virtually any size media: if the label fits in the scale, then you can use it! So long as the labels are thermal and of the proper specifications, they will work with the LP-II.

## LABELS, LABELS, & LABELS

Whether you need to print a Nutritional Panel, a Safe Handling template, a logo, or perhaps all 3, the LP-II is the scale for you! PLUs can have ingredients lists with up to 2000 characters and commodity names can have 3 lines of 38 characters. That's a whopping 2114 characters per PLU! You can select different style Nutri-facts panels, Safe Handling templates, built in logos, or design your own using the advanced software package that is included with every LP-II! The LP-II software package is designed for the Windows® 95/98/2000/XP OS.

It allows you maintain all scale programming as well as up to 999 individual label formats per "store file" About 60 label formats are provided. For updated information on label formats and other related information, don't forget to visit our website at:

[www.cas-usa.com](http://www.cas-usa.com) or [www.cas.co.kr](http://www.cas.co.kr)

**SPECIAL**

1 Dozen Roses  
APRIL 12, 1999  
\$ 29.99

1 Dozen Roses  
APRIL 12, 1999  
\$ 29.99

**SAFE HANDLING INSTRUCTIONS**  
THIS PRODUCT WILL PREPARE FROM INSPECTED AND PASSED MEAT AND/OR POULTRY. SOME FOOD PRODUCTS MAY CONTAIN BACTERIA THAT COULD CAUSE ILLNESS IF THE PRODUCT IS MISHANDLED OR COOKED IMPROPERLY. FOR YOUR PROTECTION, FOLLOW THESE SAFE HANDLING INSTRUCTIONS:  
KEEP REFRIGERATED OR FROZEN THIN IN REFRIGERATOR OR MICROWAVE.  
KEEP RAW MEAT AND POULTRY SEPARATE FROM OTHER FOODS, WASH WORKING SURFACES (INCLUDING CUTTING BOARDS), UTENSILS, AND HANDS AFTER TOUCHING RAW MEAT OR POULTRY.  
COOK THOROUGHLY.  
KEEP HOT FOODS HOT; REFRIGERATE LEFTOVERS IMMEDIATELY OR DISCARD.

CAS MART SPECIAL  
BEEF LOIN T. BONE STEAK  
(1 lb)  
02.03.99 16.03.99 0.235 5.30  
PACKED ON | SELL BY | WEIGHT | UNIT PRICE | TOTAL PRICE  
CAS SCALE CORPORATION  
475-4661

CAS MART SPECIAL  
BEEF LOIN T. BONE STEAK  
(1 lb)  
02.03.99 16.03.99 2.270  
PACKED ON | SELL BY | WEIGHT | UNIT PRICE | TOTAL PRICE  
CAS SCALE CORPORATION  
475-4661

**Turkey & Swiss CLUB SANDWICH**  
Packed On: April 17, 1999 Sell By: April 22, 1999  
ENRICHED FLOUR (WHEAT FLOUR, NIACIN, REDUCED IRON, THIAMINE, MONONITRATE, RIBOFLAVIN), WATER, PARTIALLY HYDROGENATED SOYBEAN OIL, HIGH FRUCTOSE CORN SYRUP, YEAST, SUGAR, SALT, MONO AND DIGLYCERIDES, SPICES, ENRICHED BLEACHED FLOUR (WHEAT FLOUR, NIACIN, REDUCED POLYSORBATE 60, MOLTED BARLEY FLOUR, PARTIALLY HYDROGENATED COTTONSEED OIL, FOOD STARCH, COCOA), TURKEY, WATER, MAYONNAISE, SWISS CHEESE, LETTUCE, TOMATO, ONIONS, VINAGER, OLIVE OIL, SALT, PEPPER, OREGANO, CABBAGE.  
Net Wt. 10 oz (0 lb 10 oz)  
CAS (USA) Corporation  
99 Murray Hill Parkway  
East Rutherford, NJ  
**TOTAL PRICE \$ 3.49**

**Nutrition Facts**  
Serving Size 2/3cup(153g)  
Servings Per Container about 31/2  
Amount Per Serving  
Calories 120 Calories from Fat 28  
%Daily Value\*  
Total Fat 21/2g 4%  
Saturated Fat 1/2g 3%  
Cholesterol 170mg 57%  
Sodium 140mg 6%  
Total Carbohydrate 6g 2%  
Dietary Fiber less than 1g 4%  
Sugars 2g  
Protein 4g  
Vitamin A 6% • Vitamin C 0%  
Calcium 23% • Iron 14%  
\*Percent Daily Values are based on a 2,000 calorie diet.

TOTAL PRICE \$ 3.49

PORTERHOUSE STEAK  
Family Pack  
TARE: 0.82 lb  
Pack On: Sell By: Wt/Lb  
Apr 17 Apr 28 0.895  
7.89 7.06  
# 200003 012055  
CAS (USA) Corporation  
99 Murray Hill Pky, E. Rutherford  
**SAFE HANDLING INSTRUCTIONS**  
THIS PRODUCT WILL PREPARE FROM INSPECTED AND PASSED MEAT AND/OR POULTRY. SOME FOOD PRODUCTS MAY CONTAIN BACTERIA THAT COULD CAUSE ILLNESS IF THE PRODUCT IS MISHANDLED OR COOKED IMPROPERLY. FOR YOUR PROTECTION, FOLLOW THESE SAFE HANDLING INSTRUCTIONS:  
KEEP REFRIGERATED OR FROZEN THIN IN REFRIGERATOR OR MICROWAVE.  
KEEP RAW MEAT AND POULTRY SEPARATE FROM OTHER FOODS, WASH WORKING SURFACES (INCLUDING CUTTING BOARDS), UTENSILS, AND HANDS AFTER TOUCHING RAW MEAT OR POULTRY.  
COOK THOROUGHLY.  
KEEP HOT FOODS HOT; REFRIGERATE LEFTOVERS IMMEDIATELY OR DISCARD.

**Nutrition Facts**  
Serving Size 2/3cup(153g)  
Servings Per Container about 31/2  
Amount Per Serving  
Calories 120 Calories from Fat 28  
%Daily Value\*  
Total Fat 21/2g 4%  
Saturated Fat 1/2g 3%  
Cholesterol 170mg 57%  
Sodium 140mg 6%  
Total Carbohydrate 6g 2%  
Dietary Fiber less than 1g 4%  
Sugars 2g  
Protein 4g  
Vitamin A 6% • Vitamin C 0%  
Calcium 23% • Iron 14%  
\*Percent Daily Values are based on a 2,000 calorie diet. Your daily values may be higher or lower depending on your calorie needs:  
calories 2,000 2,500  
Total Fat Less Than 65g 80g  
Sat. Fat Less Than 20g 25g  
Cholesterol Less Than 300mg 300mg  
Sodium Less Than 2,400mg 2,400mg  
Total Carbohydrate 300g 375g  
Dietary Fiber 25g 30g

**FRIED CATFISH FILLETS**  
Sell By: Packed On:  
Apr 10, 1999 Apr 8, 1999  
PCS/Price \$ Total Price \$  
1 for 3.89 3.89  
PLACE FILLETS IN A PRE-HEATED NON-STICK FRYING PAN WITH A TABLESPOON OF BUTTER OR VEGETABLE OIL. COOK ON EACH SIDE FOR 3 TO 4 MINUTES OR UNTIL FISH IS SLIGHTLY BROWNS.

**Nutrition Facts**  
Serving Size 2/3cup(153g)  
Servings Per Container about 31/2  
Amount Per Serving  
Calories 120 Calories from Fat 28  
%Daily Value\*  
Total Fat 21/2g 4%  
Saturated Fat 1/2g 3%  
Cholesterol 170mg 57%  
Sodium 140mg 6%  
Total Carbohydrate 6g 2%  
Dietary Fiber less than 1g 4%  
Sugars 2g  
Protein 4g  
Vitamin A 6% • Vitamin C 0%  
Calcium 23% • Iron 14%  
\*Percent Daily Values are based on a 2,000 calorie diet.

**Tony's Bakery**  
Est. 1938

**Freshly Baked American Apple Pie**  
9" GOURMET APPLE PIE  
ALL NATURAL, NO SUGAR ADDED

INGREDIENTS: FILLING: APPLES, SORBITOL WATER, MODIFIED CORNSTARCH, NATURAL AND ARTIFICIAL FLAVORS, ARTIFICIAL COLOR. CRUST: ENRICHED FLOUR(WHEAT FLOUR NIACIN, REDUCED IRON, THIAMINE, MONONITRATE, RIBOFLAVIN), VEGETABLE SHORTENING(PARTIALLY HYDROGENATED SOYBEAN OIL), WATER, SALT, CALCIUM PROPIONATE AS A PRESERVATIVE.

**Nutrition Facts**  
Serving Size 2/3cup(153g)  
Servings Per Container about 31/2  
Amount Per Serving  
Calories 120 Calories from Fat 28  
%Daily Value\*  
Total Fat 21/2g 4%  
Saturated Fat 1/2g 3%  
Cholesterol 170mg 57%  
Sodium 140mg 6%  
Total Carbohydrate 6g 2%  
Dietary Fiber less than 1g 4%  
Sugars 2g  
Protein 4g  
Vitamin A 6% • Vitamin C 0%  
Calcium 23% • Iron 14%  
\*Percent Daily Values are based on a 2,000 calorie diet.

Total Price \$ 12.9  
Price \$/lb 6.93  
Net Wt. lb 2.000

Thank You for shopping at Tony's!



CAS USA Corporation

NJ OFFICE

Toll Free: (800)223-4227

99 Murray Hill Parkway East Rutherford, NJ 07073

Tel: (201)933-9002 Fax: (201)933-9025

CA OFFICE

(800)678-2271

1265 Manassero St., Suite 310 Anaheim, CA 92807

Tel: (714)693-1936 Fax: (714)693-9213

Microsoft, Windows, and the Windows logos are either registered trademarks or trademarks of Microsoft Corporation in the United States and/or other countries.